

TEST REPORT

Product Name : Pocket WiFi+LAN

Model Number : Pocket WiFi+LAN

Prepared for : SOLAX POWER NETWORK TECHNOLOGY (ZHEJIANG)
CO., LTD.

Address : No.288, Shizhu Road, Tonglu Economic Development Zone,
Tonglu City, Zhejiang Province 310000, P. R. China

Prepared by : EMTEK (Dongguan) Co., Ltd.
Address : -1&2F., Building 2, Zone A, Zhongda Marine Biotechnology
Research and Development Base, No. 9, Xincheng Avenue,
Songshanhu High-technology Industrial Development Zone,
Dongguan, Guangdong, China

Tel : +86-0769-22807078

Fax: +86-0769-22807079

Report Number : EDG2301300046E01301R

Date(s) of Tests : January 30, 2023 to February 25, 2023

Date of issue : March 08, 2023



TABLE OF CONTENT

Test Report Description	Page
1. SUMMARY OF TEST RESULTS	5
2. GENERAL INFORMATION	6
2.1. Description of Device (EUT)	6
2.2. Input / Output Ports	6
2.3. Independent Operation Modes	6
2.4. Test Manner	7
2.5. Description of Test Facility	7
2.6. Test Software	7
2.7. Description of Support Device	7
2.8. Measurement Uncertainty	8
3. MEASURING DEVICE AND TEST EQUIPMENT	9
3.1. For Conducted Emissions at Mains Measurement	9
3.2. For Radiated Emission Measurement	9
4. POWER LINE CONDUCTED EMISSION MEASUREMENT	10
4.1. Block Diagram of Test Setup	10
4.2. Conducted Limit	10
4.3. Test Procedure	10
4.4. Measuring Results	11
5. RADIATED EMISSION MEASUREMENT(UP TO 1GHz)	16
5.1. Block Diagram of Test Setup	16
5.2. Radiated Limit	16
5.3. Test Procedure	16
5.4. Measuring Results	17
6. RADIATED EMISSION MEASUREMENT (ABOVE 1GHz)	22
6.1. Block Diagram of Test Setup	22
6.2. Radiated Limit	22
6.3. Test Procedure	22
6.4. Measuring Results	23
7. PHOTOGRAPHS	28
7.1. Photo of Conducted Emission Measurement	28
7.2. Photo of Radiation Emission Measurement (Up to 1GHz)	28
7.3. Photo of Radiation Emission Measurement (Above 1GHz)	29
APPENDIX A: Warning Labels (1 Page)	
APPENDIX B: Warning Statement (1 Page)	
APPENDIX C: Photos of EUT (4 Pages)	

TEST REPORT DESCRIPTION

Applicant : SOLAX POWER NETWORK TECHNOLOGY (ZHEJIANG) CO., LTD.
Manufacturer : SOLAX POWER NETWORK TECHNOLOGY (ZHEJIANG) CO., LTD.
Trade Mark : SolaX Power
EUT : Pocket WiFi+LAN
Model No. : Pocket WiFi+LAN
Power Supply : DC 5V (For PC)

Measurement Procedure Used:

FCC CFR Title 47, Part 15, Subpart B
ANSI C63.4-2014

The device described above is tested by EMTEK (DONGGUAN) CO., LTD. to determine the maximum emission levels emanating from the device and the severe levels of the device can endure and its performance criterion. The measurement results are contained in this test report and EMTEK (DONGGUAN) CO., LTD. is assumed full of responsibility for the accuracy and completeness of these measurements. Also, this report shows that the EUT (Equipment Under Test) is technically compliant with the FCC requirements.

This report applies to above tested sample only and shall not be reproduced in part without written approval of EMTEK (DONGGUAN) CO., LTD.

Date of Test : January 30, 2023 to February 25, 2023

Prepared by : 
Galen Xiao /Editor

Reviewer : 
Tim Dong /Supervisor

Approved & Authorized Signer : 
Sam Lv /Manager



Modified Information

Version	Report No.	Revision date	Summary
	EDG2301300046E01301R	/	Original Report



1. SUMMARY OF TEST RESULTS

EMISSION		
Description of Test Item	Standard & Limits	Results
Conducted Emission at Mains Terminals	FCC CFR Title 47, Part 15, Subpart B, Class B ANSI C63.4-2014	Pass
Radiated Emission	FCC CFR Title 47, Part 15, Subpart B, Class B ANSI C63.4-2014	Pass
Note: N/A is an abbreviation for Not Applicable.		



2. GENERAL INFORMATION

2.1. Description of Device (EUT)

EUT : Pocket WiFi+LAN

Model Number : Pocket WiFi+LAN

Test Voltage : AC 120V/60Hz (For Support Device), DC 5V

Highest Frequency : 2400 MHz

Sample Number : EDG2301300046E013-1-1

Applicant : SOLAX POWER NETWORK TECHNOLOGY (ZHEJIANG) CO., LTD.

Address : No.288, Shizhu Road, Tonglu Economic Development Zone, Tonglu City, Zhejiang Province 310000, P. R. China

Manufacturer : SOLAX POWER NETWORK TECHNOLOGY (ZHEJIANG) CO., LTD.

Address : No.288, Shizhu Road, Tonglu Economic Development Zone, Tonglu City, Zhejiang Province 310000, P. R. China

Date of Received : January 30, 2023

Date of Test : January 30, 2023 to February 25, 2023

2.2. Input / Output Ports

Port #	Name	Type*	Cable Max. >3m	Cable Shielded	Comments
1	Enclosure	N/E	--	--	None
2	USB Port	DC	--	--	None

* Note: Use abbreviations:

AC= AC Power Port

DC= DC Power Port

N/E= Non-Electrical

I/O= Signal Input or Output Port (Not Involved in Process Control)

TP= Telecommunication Ports

2.3. Independent Operation Modes

- A. WIFI
- B. WIRED

2.4. Test Manner

Test Items	Test Voltage	Operation Modes	Worst case
Conducted Emission at Mains Terminals	AC 120V/60Hz	Mode A Mode B	Mode A Mode B
Radiated Emission up to 1 GHz	DC 5V	Mode A Mode B	Mode A Mode B
Radiated Emission above 1 GHz	DC 5V	Mode A Mode B	Mode A Mode B

2.5. Description of Test Facility

Site Description

EMC Lab. : Accredited by CNAS, 2020.08.27
 The certificate is valid until 2024.07.05
 The Laboratory has been assessed and proved to be in compliance with CNAS/CL01:2018
 The Certificate Registration Number is L3150

Accredited by FCC
 Designation Number: CN1300
 Test Firm Registration Number: 945551

Accredited by A2LA, April 05, 2021
 The Certificate Registration Number is 4321.02

Accredited by Industry Canada
 The Certificate Registration Number is CN0113

Name of Firm : EMTEK (DONGGUAN) CO., LTD.
 Site Location : -1&2F., Building 2, Zone A, Zhongda Marine Biotechnology Research and Development Base, No. 9, Xincheng Avenue, Songshanhu High-technology Industrial Development Zone, Dongguan, Guangdong, China

2.6. Test Software

Item Software
 Conducted Emission : TS+ (Ver. 4.0.0.0)
 Disturbance Power : TS+ (Ver. 4.0.0.0)

2.7. Description of Support Device

Notebook : Manufacturer: LENOVO
 M/N: T430s
 S/N: R9RK4YK

2.8. Measurement Uncertainty

Test Item	Uncertainty
Conducted Emission Uncertainty	: 2.08dB(9k~150kHz Conduction 1#) 2.42dB(150k-30MHz Conduction 1#)
Radiated Emission Uncertainty (3m Chamber)	: 3.32dB (30M~1GHz Polarize: H) 3.34dB (30M~1GHz Polarize: V) 4.98dB (1~6GHz) 5.20dB (6~18GHz)



3. MEASURING DEVICE AND TEST EQUIPMENT

3.1. For Conducted Emissions at Mains Measurement

No.	Equipment	Manufacturer	Model No.	Serial No.	Last Cal.	Cal. Interval
1.	Test Receiver	Rohde& Schwarz	ESCI	100137	2022/5/19	1Year
2.	L.I.S.N.	Rohde& Schwarz	ENV216	101209	2022/5/19	1Year

3.2. For Radiated Emission Measurement

No.	Equipment	Manufacturer	Model No.	Serial No.	Last Cal.	Cal. Interval
1.	EMI Test Receiver	Rohde & Schwarz	ESCI	101415	2022/5/19	1Year
2.	Bilog Antenna	Schwarzbeck	VULB9163	141	2022/5/22	1Year
3.	Power Amplifier	HP	8447F	OPH64	2022/5/19	1Year
4.	Cable	N/A	CIL02	A0783566	2022/5/19	1Year
5.	Cable	N/A	RG 223/U	525178	2022/5/19	1Year
6.	Cable	N/A	RG 223/U	525179	2022/5/19	1Year
7.	Signal Analyzer	R&S	FSV30	103039	2022/5/19	1Year
8.	Horn Antenna	Schwarzbeck	BBHA9120D	1272	2022/5/22	1Year
9.	High frequency horn antenna	Schwarzbeck	BBHA9170	9170-567	2022/5/22	1Year
10.	Power Amplifier	LUNAR EM	PM1-18-40	J1010000008 1	2022/5/19	1Year
11.	Cable	N/A	CBL-26	D1245	2022/5/19	1Year
12.	Cable	N/A	CBL-26	D8503	2022/5/19	1Year
13.	Cable	N/A	CBL-26	N/A	2022/5/19	1Year

4. POWER LINE CONDUCTED EMISSION MEASUREMENT

4.1. Block Diagram of Test Setup

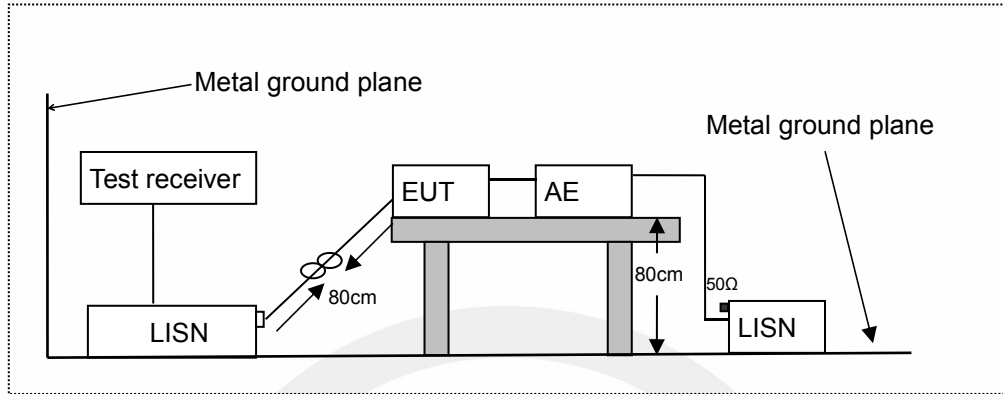

LISN: Line Impedance Stabilization Network
 AE: Associated equipment
 EUT: Equipment under test

4.2. Conducted Limit

FCC CFR Title 47, Part 15, Subpart B, Class B

Frequency (MHz)	Limit (dB μ V)	
	Quasi-peak Level	Average Level
0.15 ~ 0.50	66.0 ~ 56.0 *	56.0 ~ 46.0 *
0.50 ~ 5.00	56.0	46.0
5.00 ~ 30.00	60.0	50.0

NOTE1-The lower limit shall apply at the transition frequencies.
 NOTE2-The limit decreases linearly with the logarithm of the frequency in the range 0.15MHz to 0.50MHz.

4.3. Test Procedure

The EUT was placed on a desk 0.8 m height from the metal ground plane and 0.4 m from the conducting wall of the shielding room and it was kept at least 0.8 m from any other grounded conducting surface. The size of the table will nominally be 1.5 m x1.0 m.

The rear of the arrangement shall be flush with the back of the supporting tabletop unless that would not be possible or typical of normal use.

All units of equipment forming the system under test (includes the EUT as well as connected peripherals and associated equipment or devices) shall be arranged such that a nominal 0.1 m separation is achieved between the neighboring units.

Connect EUT to the power mains through a line impedance stabilization network (LISN). Where the mains cable supplied by the manufacturer is longer than 1 m, the excess should be folded at the centre into a bundle no longer than 0.4 m, so that its length is shortened to 1 m.

All the support units are connecting to the other LISN.

The LISN provides 50 ohm coupling impedance for the measuring instrument.

Both sides of AC line were checked for maximum conducted interference.

The frequency range from 150 kHz to 30 MHz was sweep.

Set the test-receiver system to quasi peak detect function and average detect function, and to measure the conducted emissions values.

Test results were obtained from the following equation:
Measurement (dB μ V) = Correct Factor (dB) + Reading (dB μ V)
Over (dB) = Measurement (dB μ V) - Limit (dB μ V)

4.4. Measuring Results

Pass.

Please refer to following pages.



Project Information			
Mode:	WIFI	Voltage:	AC 120V/60Hz
Environment:	Temp: 25°C; Humi:52%	Engineer:	Allen Tang

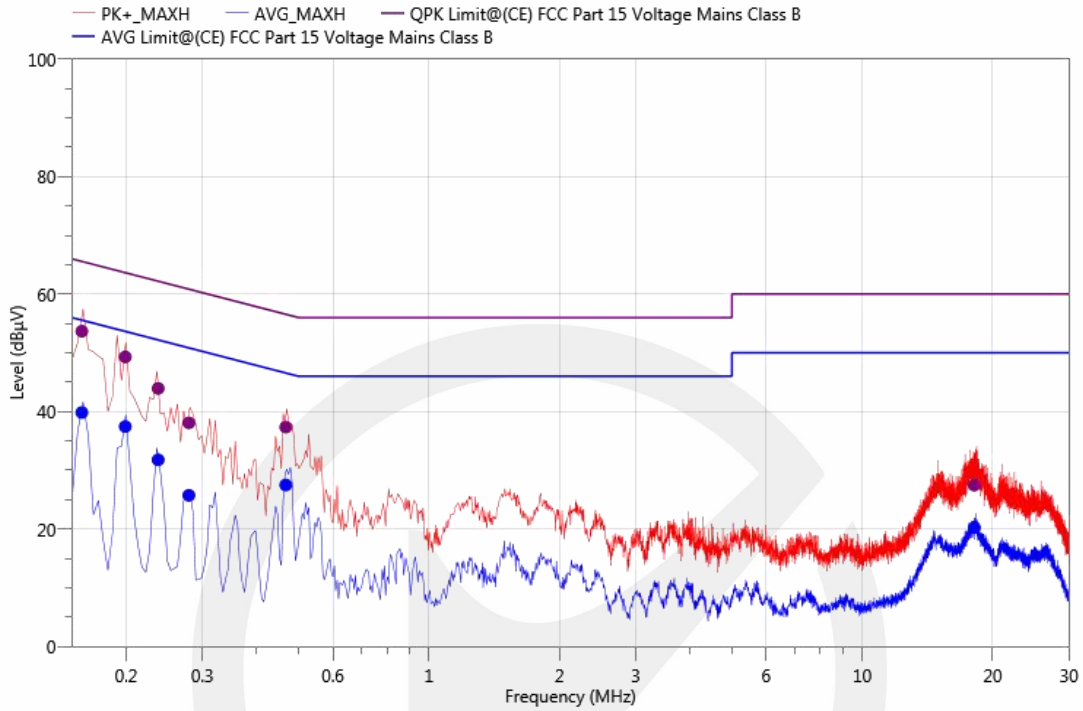

Freq. (MHz)	Reading (dBµV)	Meas. (dBµV)	Limit (dBµV)	Margin (dB)	Det.	Line	PE	Corr. (dB)	Verdict
0.16	43.60	53.68	65.57	11.89	QPK	N	GND	10.08	Pass
0.16	29.75	39.83	55.57	15.74	AVG	N	GND	10.08	Pass
0.20	39.19	49.31	63.65	14.34	QPK	N	GND	10.12	Pass
0.20	27.32	37.44	53.65	16.21	AVG	N	GND	10.12	Pass
0.24	33.81	43.94	62.20	18.26	QPK	N	GND	10.13	Pass
0.24	21.65	31.78	52.20	20.42	AVG	N	GND	10.13	Pass
0.28	27.92	38.07	60.85	22.78	QPK	N	GND	10.15	Pass
0.28	15.58	25.73	50.85	25.12	AVG	N	GND	10.15	Pass
0.47	27.25	37.35	56.57	19.22	QPK	N	GND	10.1	Pass
0.47	17.39	27.49	46.57	19.08	AVG	N	GND	10.1	Pass
18.13	16.34	27.47	60.00	32.53	QPK	N	GND	11.13	Pass
18.13	9.11	20.24	50.00	29.76	AVG	N	GND	11.13	Pass

Project Information			
Mode:	WIFI	Voltage:	AC 120V/60Hz
Environment:	Temp: 25°C; Humi:52%	Engineer:	Allen Tang

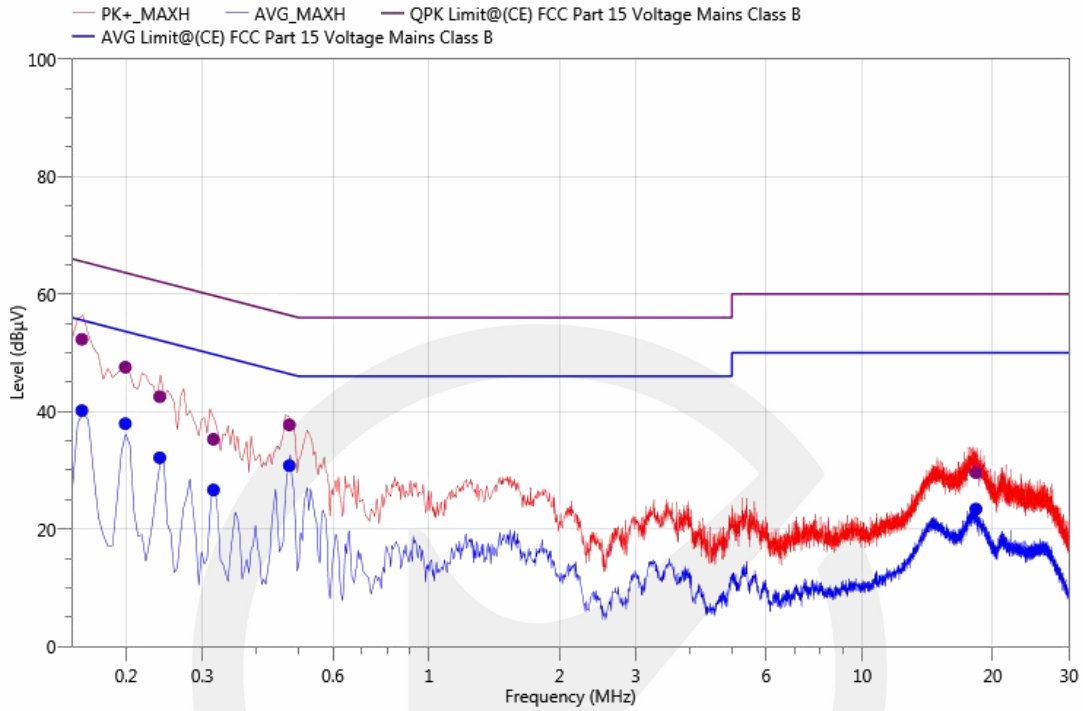

Freq. (MHz)	Reading (dBµV)	Meas. (dBµV)	Limit (dBµV)	Margin (dB)	Det.	Line	PE	Corr. (dB)	Verdict
0.16	42.24	52.30	65.57	13.27	QPK	L1	GND	10.06	Pass
0.16	30.10	40.16	55.57	15.41	AVG	L1	GND	10.06	Pass
0.20	37.42	47.55	63.65	16.1	QPK	L1	GND	10.13	Pass
0.20	27.80	37.93	53.65	15.72	AVG	L1	GND	10.13	Pass
0.24	32.40	42.52	62.13	19.61	QPK	L1	GND	10.12	Pass
0.24	22.01	32.13	52.13	20	AVG	L1	GND	10.12	Pass
0.32	25.08	35.28	59.76	24.48	QPK	L1	GND	10.2	Pass
0.32	16.44	26.64	49.76	23.12	AVG	L1	GND	10.2	Pass
0.48	27.53	37.73	56.41	18.68	QPK	L1	GND	10.2	Pass
0.48	20.59	30.79	46.41	15.62	AVG	L1	GND	10.2	Pass
18.29	18.57	29.60	60.00	30.4	QPK	L1	GND	11.03	Pass
18.29	12.36	23.39	50.00	26.61	AVG	L1	GND	11.03	Pass

Project Information			
Mode:	WIRED	Voltage:	AC 120V/60Hz
Environment:	Temp: 25°C; Humi:52%	Engineer:	Allen Tang

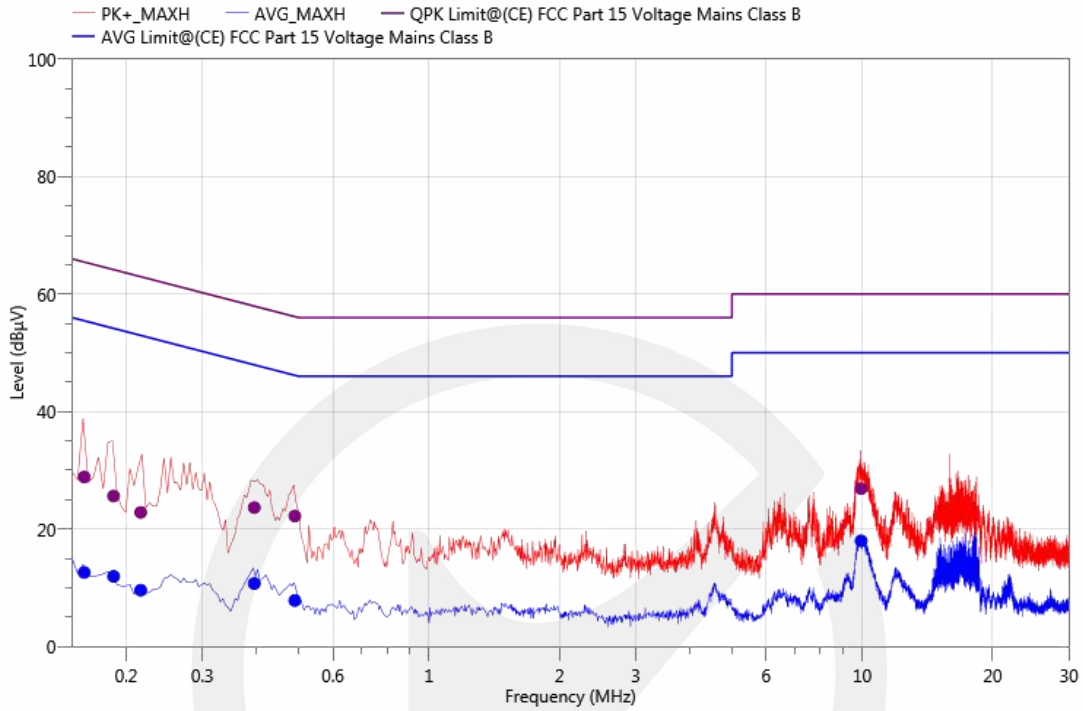

Freq. (MHz)	Reading (dBµV)	Meas. (dBµV)	Limit (dBµV)	Margin (dB)	Det.	Line	PE	Corr. (dB)	Verdict
0.16	18.80	28.86	65.46	36.6	QPK	L1	GND	10.06	Pass
0.16	2.53	12.59	55.46	42.87	AVG	L1	GND	10.06	Pass
0.19	15.50	25.61	64.17	38.56	QPK	L1	GND	10.11	Pass
0.19	1.82	11.93	54.17	42.24	AVG	L1	GND	10.11	Pass
0.22	12.70	22.83	62.97	40.14	QPK	L1	GND	10.13	Pass
0.22	-0.56	9.57	52.97	43.4	AVG	L1	GND	10.13	Pass
0.40	13.12	23.65	57.96	34.31	QPK	L1	GND	10.53	Pass
0.40	0.18	10.71	47.96	37.25	AVG	L1	GND	10.53	Pass
0.49	12.06	22.20	56.17	33.97	QPK	L1	GND	10.14	Pass
0.49	-2.32	7.82	46.17	38.35	AVG	L1	GND	10.14	Pass
9.94	16.15	26.87	60.00	33.13	QPK	L1	GND	10.72	Pass
9.94	7.26	17.98	50.00	32.02	AVG	L1	GND	10.72	Pass

Project Information			
Mode:	WIRED	Voltage:	AC 120V/60Hz
Environment:	Temp: 25°C; Humi:52%	Engineer:	Allen Tang

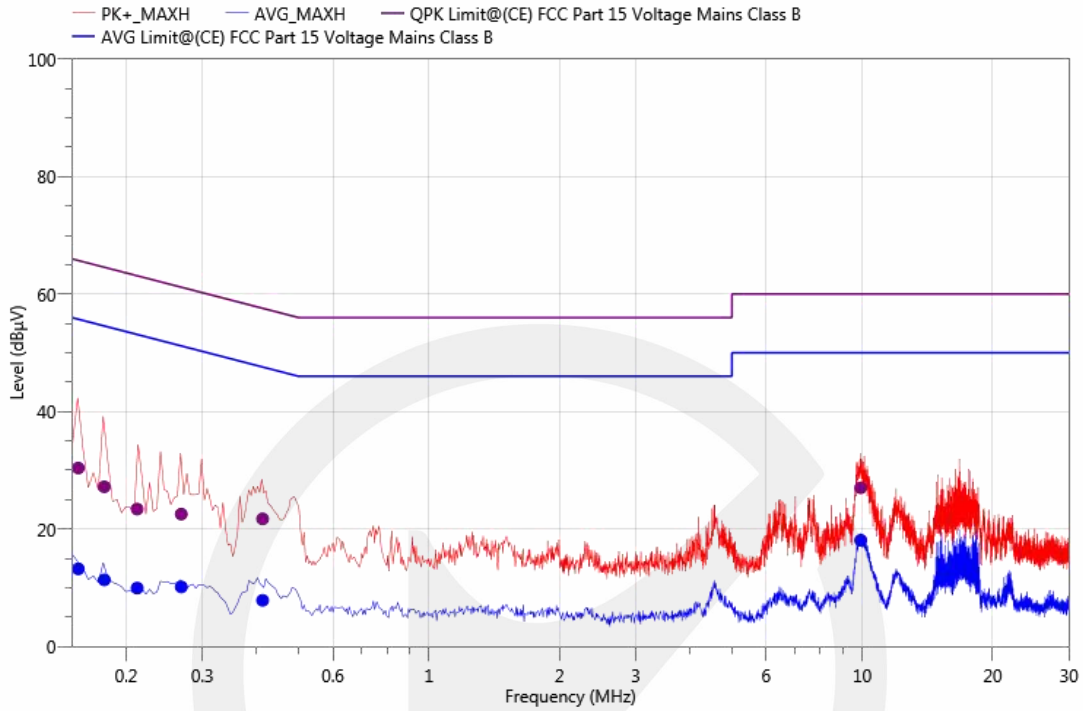

Freq. (MHz)	Reading (dBµV)	Meas. (dBµV)	Limit (dBµV)	Margin (dB)	Det.	Line	PE	Corr. (dB)	Verdict
0.16	20.30	30.38	65.73	35.35	QPK	N	GND	10.08	Pass
0.16	3.13	13.21	55.73	42.52	AVG	N	GND	10.08	Pass
0.18	17.09	27.19	64.58	37.39	QPK	N	GND	10.1	Pass
0.18	1.23	11.33	54.58	43.25	AVG	N	GND	10.1	Pass
0.21	13.27	23.39	63.13	39.74	QPK	N	GND	10.12	Pass
0.21	-0.19	9.93	53.13	43.2	AVG	N	GND	10.12	Pass
0.27	12.39	22.54	61.18	38.64	QPK	N	GND	10.15	Pass
0.27	-0.02	10.13	51.18	41.05	AVG	N	GND	10.15	Pass
0.41	11.63	21.73	57.59	35.86	QPK	N	GND	10.1	Pass
0.41	-2.25	7.85	47.59	39.74	AVG	N	GND	10.1	Pass
9.92	16.25	27.02	60.00	32.98	QPK	N	GND	10.77	Pass
9.92	7.31	18.08	50.00	31.92	AVG	N	GND	10.77	Pass

5. RADIATED EMISSION MEASUREMENT(UP TO 1GHz)

5.1. Block Diagram of Test Setup

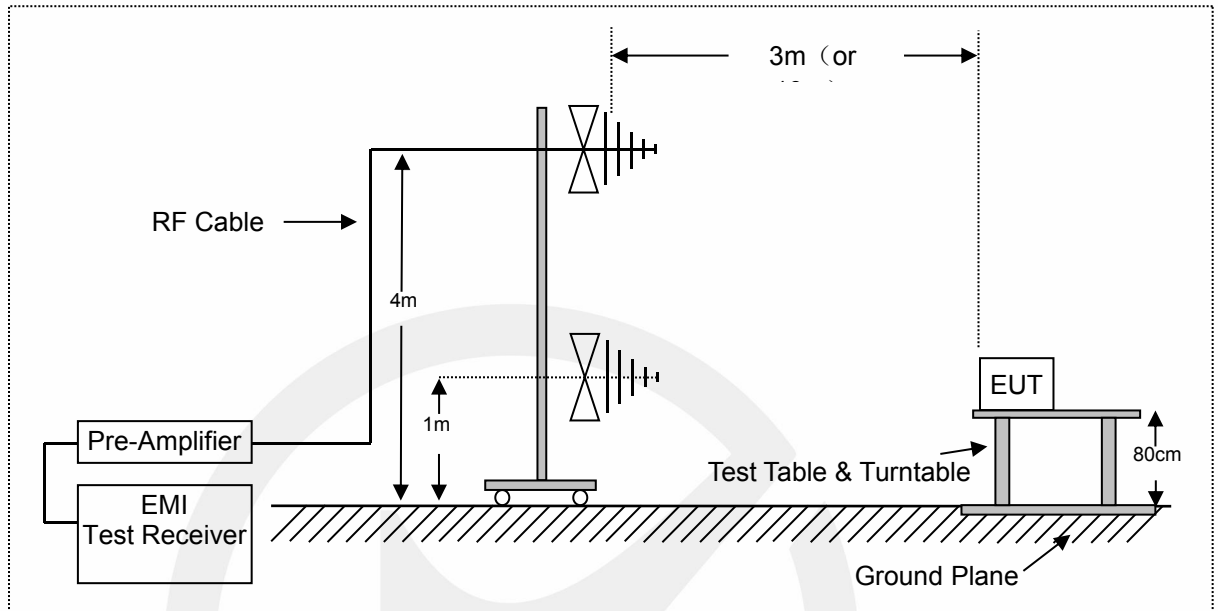

5.2. Radiated Limit

FCC CFR Title 47, Part 15, Subpart B, Class B

Frequency MHz	Distance Meters	Field Strengths Limit	
		$\mu\text{V}/\text{m}$	$\text{dB}(\mu\text{V})/\text{m}$
30 ~ 88	3	100	40.0
88 ~ 216	3	150	43.5
216 ~ 960	3	200	46.0
960 ~ 1000	3	500	54.0

5.3. Test Procedure

The EUT was placed on a non-conductive table whose total height equaled 80cm. All units of equipment forming the system under test (includes the EUT as well as connected peripherals and associated equipment or devices) shall be arranged such that a nominal 0.1 m separation is achieved between the neighboring units. Where the mains cable supplied by the manufacturer is longer than 1 m, the excess should be folded at the centre into a bundle no longer than 0.4 m, so that its length is shortened to 1 m.

The EUT was set 3 meters away from the receiving antenna that was mounted on a non-conductive mast. The antenna can move up and down between 1 to 4 meters to find out the maximum emission level.

The turntable can rotate 360 degree to determine the position of the maximum emission level.

The initial testing identified the frequency that has the highest disturbance relative to the limit while operating the EUT in typical modes of operation and cable positions in a test setup representative of typical system configuration.

The identification of the frequency of highest emission with respect to the limit was found by investigating emissions at a number of significant frequencies. The probable frequency of maximum emission had been found and that the associated cable and EUT configuration and mode of operation had been identified.

The bandwidth of the Receiver is set at 120 kHz.

Test results were obtained from the following equation:

Measurement (dB μ V) = Correct Factor (dB) + Reading (dB μ V)

Over (dB) = Measurement (dB μ V) - Limit (dB μ V)

5.4. Measuring Results

Pass.

Please refer to following pages.



Project Information			
Mode:	WIFI	Voltage:	DC 5V
Environment:	Temp: 16°C; Humi:58%	Engineer:	Jackson Xue

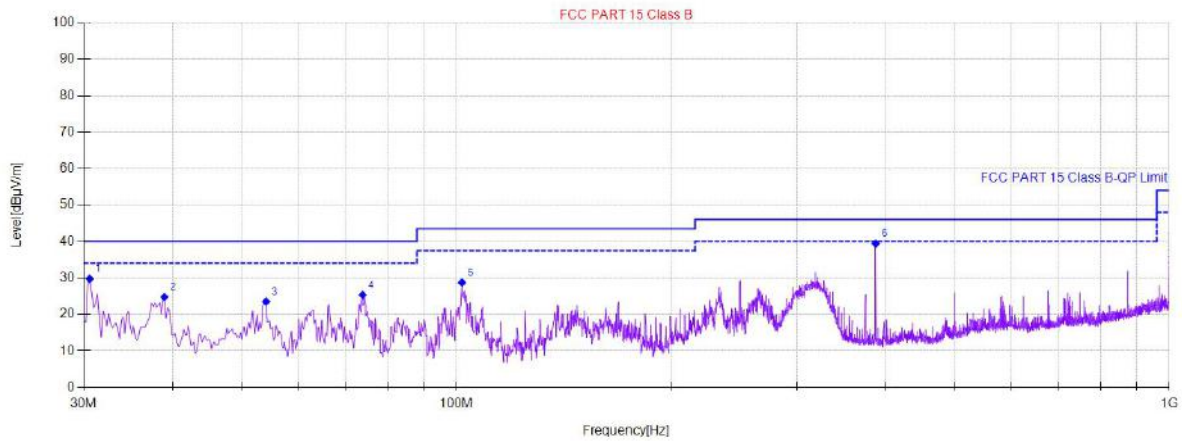

Final Data List										
NO.	Freq. [MHz]	QP Reading [dBµV/m]	Factor [dB]	QP Value [dBµV/m]	QP Limit [dBµV/m]	QP Margin [dB]	Height [cm]	Angle [°]	Polarity	Verdict
1	30.5821	61.09	-31.35	29.74	40.00	10.26	100	339	Vertical	Pass
2	38.9258	55.46	-30.68	24.78	40.00	15.22	100	10	Vertical	Pass
3	54.0608	54.40	-30.89	23.51	40.00	16.49	100	227	Vertical	Pass
4	73.8528	58.38	-33.03	25.35	40.00	14.65	100	292	Vertical	Pass
5	101.7944	60.20	-31.46	28.74	43.50	14.76	100	136	Vertical	Pass
6	387.4195	65.92	-26.50	39.42	46.00	6.58	100	156	Vertical	Pass

Project Information			
Mode:	WIFI	Voltage:	DC 5V
Environment:	Temp: 16°C; Humi:58%	Engineer:	Jackson Xue

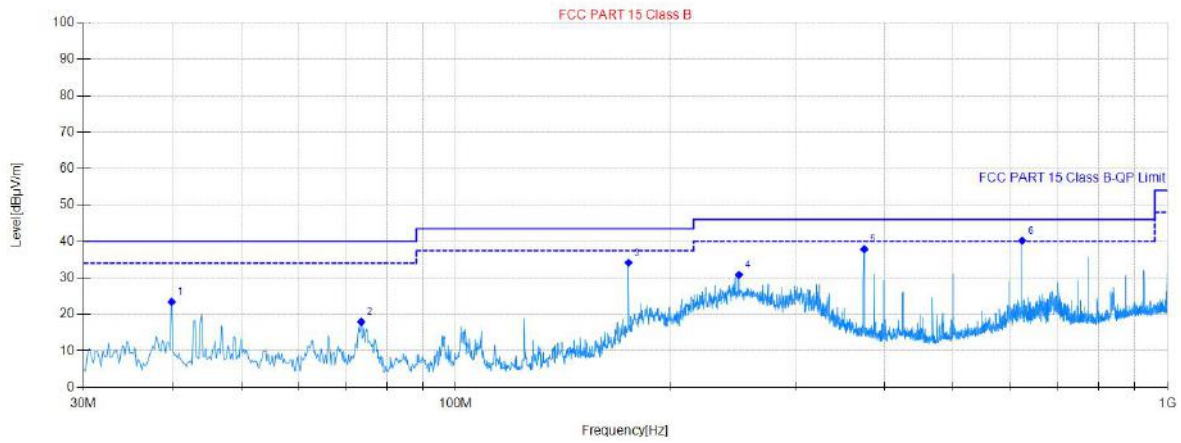

Final Data List										
NO.	Freq. [MHz]	QP Reading [dBµV/m]	Factor [dB]	QP Value [dBµV/m]	QP Limit [dBµV/m]	QP Margin [dB]	Height [cm]	Angle [°]	Polarity	Verdict
1	39.896	54.03	-30.60	23.43	40.00	16.57	100	234	Horizontal	Pass
2	73.6587	50.99	-33.04	17.95	40.00	22.05	100	18	Horizontal	Pass
3	174.947	66.49	-32.32	34.17	43.50	9.33	100	64	Horizontal	Pass
4	250.04	59.62	-28.77	30.85	46.00	15.15	100	269	Horizontal	Pass
5	375.001	64.17	-26.28	37.89	46.00	8.11	100	290	Horizontal	Pass
6	625.117	61.31	-21.08	40.23	46.00	5.77	100	121	Horizontal	Pass

Project Information			
Mode:	WIRED	Voltage:	DC 5V
Environment:	Temp: 16°C; Humi:58%	Engineer:	Jackson Xue

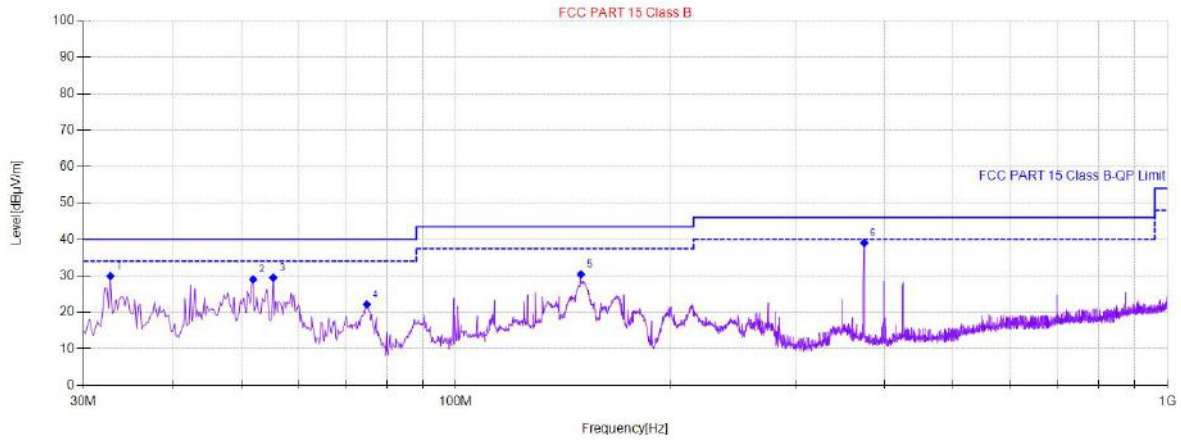

Final Data List										
NO.	Freq. [MHz]	QP Reading [dBµV/m]	Factor [dB]	QP Value [dBµV/m]	QP Limit [dBµV/m]	QP Margin [dB]	Height [cm]	Angle [°]	Polarity	Verdict
1	32.7165	61.11	-31.18	29.93	40.00	10.07	100	207	Vertical	Pass
2	51.9264	59.59	-30.52	29.07	40.00	10.93	100	251	Vertical	Pass
3	55.4191	60.65	-31.12	29.53	40.00	10.47	100	152	Vertical	Pass
4	75.017	55.21	-33.02	22.19	40.00	17.81	100	227	Vertical	Pass
5	149.916	63.39	-32.97	30.42	43.50	13.08	100	336	Vertical	Pass
6	375.001	65.34	-26.28	39.06	46.00	6.94	100	264	Vertical	Pass

Project Information			
Mode:	WIRED	Voltage:	DC 5V
Environment:	Temp: 16°C; Humi:58%	Engineer:	Jackson Xue

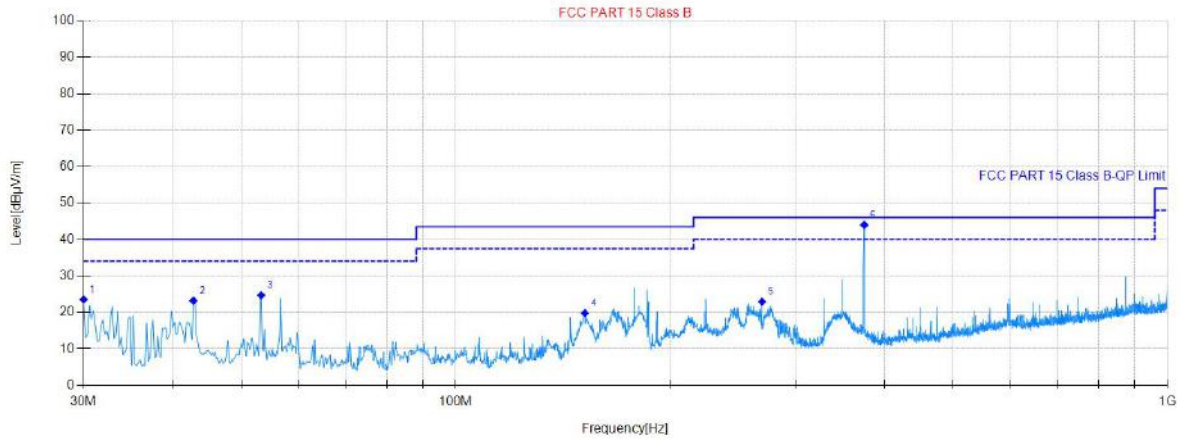

Final Data List										
NO.	Freq. [MHz]	QP Reading [dBµV/m]	Factor [dB]	QP Value [dBµV/m]	QP Limit [dBµV/m]	QP Margin [dB]	Height [cm]	Angle [°]	Polarity	Verdict
1	30	54.95	-31.40	23.55	40.00	16.45	100	258	Horizontal	Pass
2	42.8066	53.50	-30.31	23.19	40.00	16.81	100	242	Horizontal	Pass
3	53.2847	55.46	-30.75	24.71	40.00	15.29	100	73	Horizontal	Pass
4	151.8564	52.76	-32.97	19.79	43.50	23.71	100	305	Horizontal	Pass
5	269.4439	51.77	-28.85	22.92	46.00	23.08	100	204	Horizontal	Pass
6	375.001	70.28	-26.28	44.00	46.00	2.00	100	336	Horizontal	Pass

6. RADIATED EMISSION MEASUREMENT (ABOVE 1GHz)

6.1. Block Diagram of Test Setup

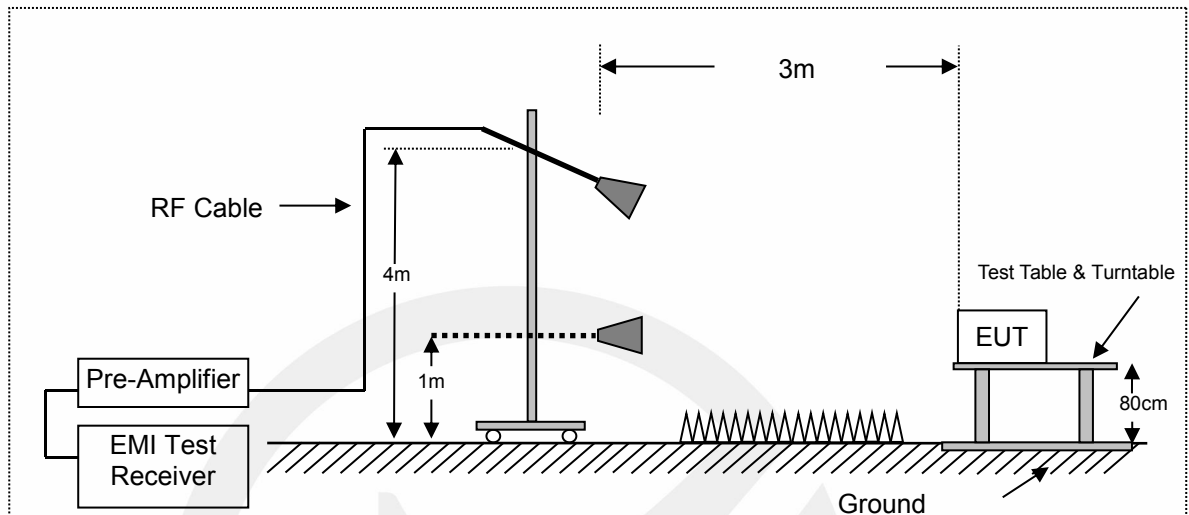

6.2. Radiated Limit

FCC CFR Title 47, Part 15, Subpart B, Class B

Frequency range GHz	Average limit dB(μV/m)	Peak limit dB(μV/m)
Above 1000	54	74

Note: The highest internal source of an EUT is defined as the highest frequency generated or used in the device or on which the EUT operates or tunes. If the highest frequency of the internal sources of the EUT is less than 1.705 MHz, the measurement shall only be made up to 30 MHz. If the highest frequency of the internal sources of the EUT is between 1.705 MHz and 108 MHz, the measurement shall only be made up to 1 GHz. If the highest frequency of the internal sources of the EUT is between 108 MHz and 500 MHz the measurement shall only be made up to 2 GHz. If the highest frequency of the internal sources of the EUT is between 500 MHz and 1 GHz, the measurement shall only be made up to 5 GHz. If the highest frequency of the internal sources of the EUT is above 1 GHz, the measurement shall be made up to 5 times the highest frequency or 40 GHz, whichever is less.

6.3. Test Procedure

The EUT was placed on a non-conductive table whose total height equaled 80cm. All units of equipment forming the system under test (includes the EUT as well as connected peripherals and associated equipment or devices) shall be arranged such that a nominal 0.1 m separation is achieved between the neighboring units. Where the mains cable supplied by the manufacturer is longer than 1 m, the excess should be folded at the centre into a bundle no longer than 0.4 m, so that its length is shortened to 1 m.

The EUT was set 3 meters away from the receiving antenna that was mounted on a non-conductive mast. The antenna can move up and down between 1 to 4 meters to find out the maximum emission level.

The turntable can rotate 360 degree to determine the position of the maximum emission level.

The initial testing identified the frequency that has the highest disturbance relative to the limit while operating the EUT in typical modes of operation and cable positions in a test setup representative of typical system configuration.

The identification of the frequency of highest emission with respect to the limit was found by investigating emissions at a number of significant frequencies. The probable frequency of maximum emission had been found and that the associated cable and EUT configuration and mode of operation had been identified.

The frequency range above 1GHz the measuring instrument use RBW=1 MHz and VBW=3 MHz with peak detector for peak values, and use RBW=1 MHz and VBW=10 Hz with peak detector for Average Values.

Test results were obtained from the following equation:
Measurement (dB μ V) =Correct Factor (dB) + Reading (dB μ V)
Over (dB) = Measurement (dB μ V) - Limit (dB μ V)

6.4. Measuring Results

Pass.

Please refer to following pages.



Project Information			
Mode:	WIFI	Voltage:	DC 5V
Environment:	Temp: 16°C; Humi:48%	Engineer:	Jackson Xue

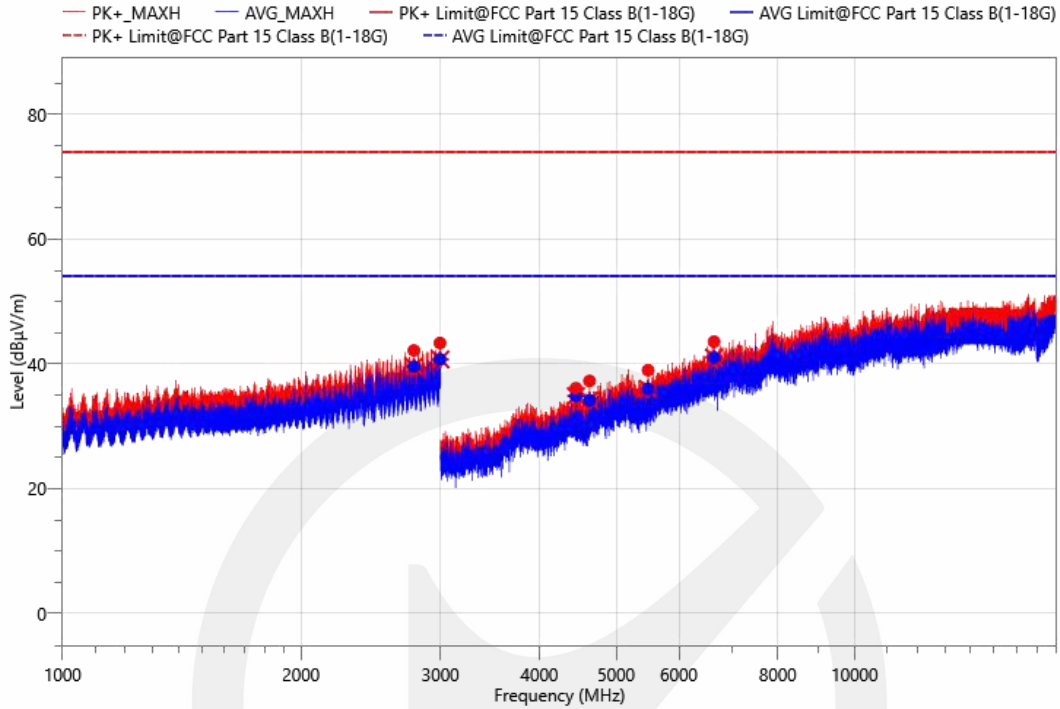

Freq. (MHz)	Reading (dBµV)	Meas. (dBµV/m)	Limit (dBµV/m)	Margin (dBµV/m)	Det.	Height (cm)	Pol.	Azimuth (deg)	Corr. (dB)	Verdict
2777.00	50.50	42.16	74.00	31.84	PK+	100.0	V	229.0	-8.34	Pass
2777.00	47.92	39.58	54.00	14.42	AVG	100.0	V	229.0	-8.34	Pass
2995.50	50.60	43.36	74.00	30.64	PK+	100.0	V	229.0	-7.24	Pass
2995.50	47.97	40.73	54.00	13.27	AVG	100.0	V	229.0	-7.24	Pass
4448.50	44.41	36.11	74.00	37.89	PK+	100.0	V	229.0	-8.3	Pass
4448.50	43.16	34.86	54.00	19.14	AVG	100.0	V	229.0	-8.3	Pass
4627.00	45.31	37.27	74.00	36.73	PK+	100.0	V	229.0	-8.04	Pass
4627.00	42.20	34.16	54.00	19.84	AVG	100.0	V	229.0	-8.04	Pass
5486.00	44.64	39.00	74.00	35	PK+	100.0	V	229.0	-5.64	Pass
5486.00	41.63	35.99	54.00	18.01	AVG	100.0	V	229.0	-5.64	Pass
6646.00	44.84	43.58	74.00	30.42	PK+	100.0	V	229.0	-1.26	Pass
6646.00	42.29	41.03	54.00	12.97	AVG	100.0	V	229.0	-1.26	Pass

Project Information			
Mode:	WIFI	Voltage:	DC 5V
Environment:	Temp: 16°C; Humi:48%	Engineer:	Jackson Xue

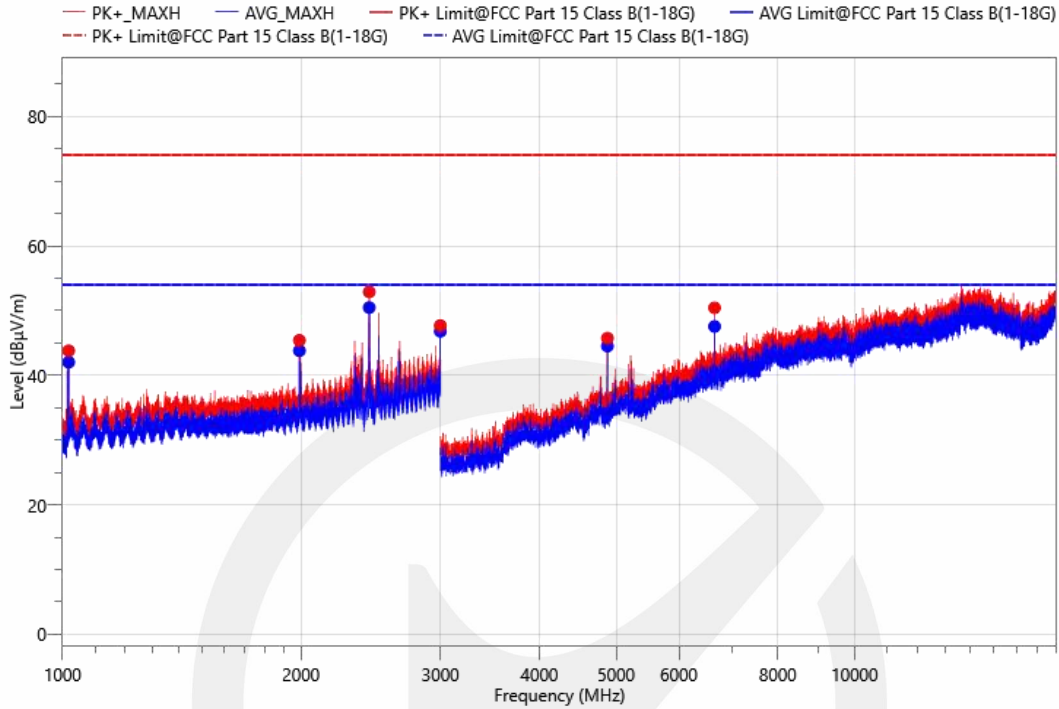

Freq. (MHz)	Reading (dBµV)	Meas. (dBµV/m)	Limit (dBµV/m)	Margin (dBµV/m)	Det.	Height (cm)	Pol.	Azimuth (deg)	Corr. (dB)	Verdict
1017.75	58.71	43.81	74.00	30.19	PK+	150.0	V	0.0	-14.9	Pass
1017.75	56.94	42.04	54.00	11.96	AVG	150.0	V	0.0	-14.9	Pass
1990.63	56.90	45.42	74.00	28.58	PK+	150.0	V	0.0	-11.48	Pass
1990.63	55.30	43.82	54.00	10.18	AVG	150.0	V	0.0	-11.48	Pass
2438.63	62.40	52.90	74.00	21.1	PK+	150.0	V	0.0	-9.5	Pass
2438.63	59.98	50.48	54.00	3.52	AVG	150.0	V	0.0	-9.5	Pass
2998.69	54.91	47.70	74.00	26.3	PK+	150.0	V	0.0	-7.21	Pass
2998.69	54.02	46.81	54.00	7.19	AVG	150.0	V	0.0	-7.21	Pass
4874.00	52.84	45.76	74.00	28.24	PK+	150.0	V	0.0	-7.08	Pass
4874.00	51.61	44.53	54.00	9.47	AVG	150.0	V	0.0	-7.08	Pass
6655.50	51.69	50.44	74.00	23.56	PK+	150.0	V	0.0	-1.25	Pass
6655.50	48.81	47.56	54.00	6.44	AVG	150.0	V	0.0	-1.25	Pass

Project Information			
Mode:	WIRED	Voltage:	DC 5V
Environment:	Temp: 16°C; Humi:48%	Engineer:	Jackson Xue

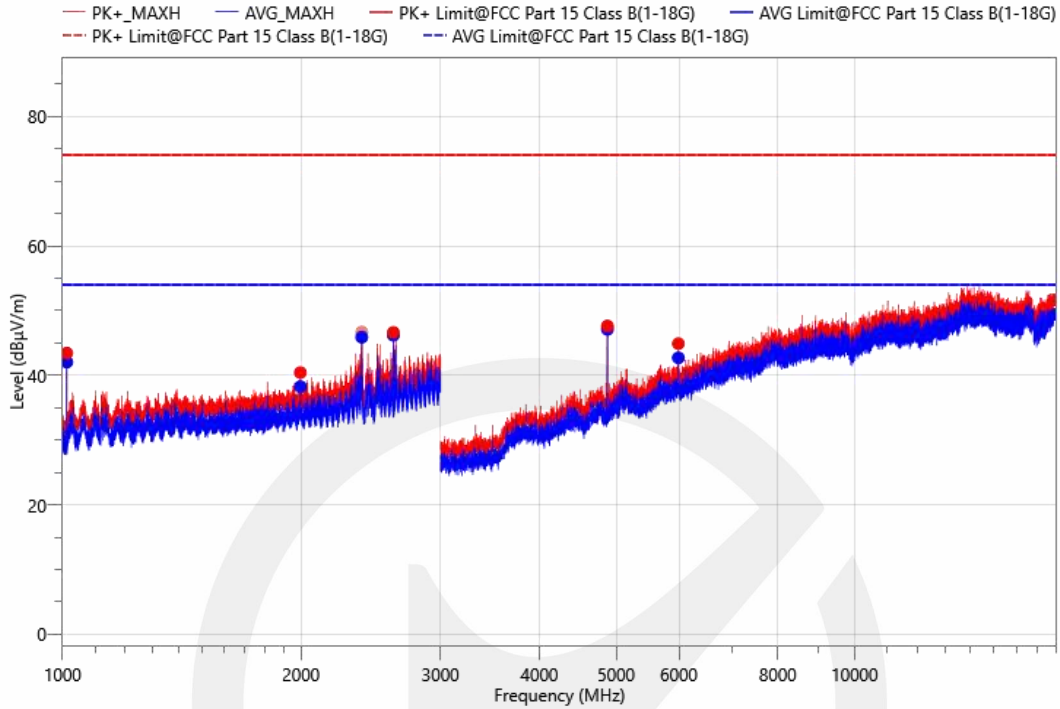

Freq. (MHz)	Reading (dBµV)	Meas. (dBµV/m)	Limit (dBµV/m)	Margin (dBµV/m)	Det.	Height (cm)	Pol.	Azimuth (deg)	Corr. (dB)	Verdict
1012.19	58.33	43.45	74.00	30.55	PK+	150.0	H	0.0	-14.88	Pass
1012.19	56.94	42.06	54.00	11.94	AVG	150.0	H	0.0	-14.88	Pass
1996.19	51.90	40.43	74.00	33.57	PK+	150.0	H	0.0	-11.47	Pass
1996.19	49.73	38.26	54.00	15.74	AVG	150.0	H	0.0	-11.47	Pass
2386.25	56.40	46.71	74.00	27.29	PK+	150.0	H	0.0	-9.69	Pass
2386.25	55.59	45.90	54.00	8.1	AVG	150.0	H	0.0	-9.69	Pass
2615.63	55.79	46.65	74.00	27.35	PK+	150.0	H	0.0	-9.14	Pass
2615.63	55.34	46.20	54.00	7.8	AVG	150.0	H	0.0	-9.14	Pass
4874.00	54.72	47.64	74.00	26.36	PK+	150.0	H	0.0	-7.08	Pass
4874.00	54.19	47.11	54.00	6.89	AVG	150.0	H	0.0	-7.08	Pass
5991.00	48.44	44.91	74.00	29.09	PK+	150.0	H	0.0	-3.53	Pass
5991.00	46.25	42.72	54.00	11.28	AVG	150.0	H	0.0	-3.53	Pass

Project Information			
Mode:	WIRED	Voltage:	DC 5V
Environment:	Temp: 16°C; Humi:48%	Engineer:	Jackson Xue

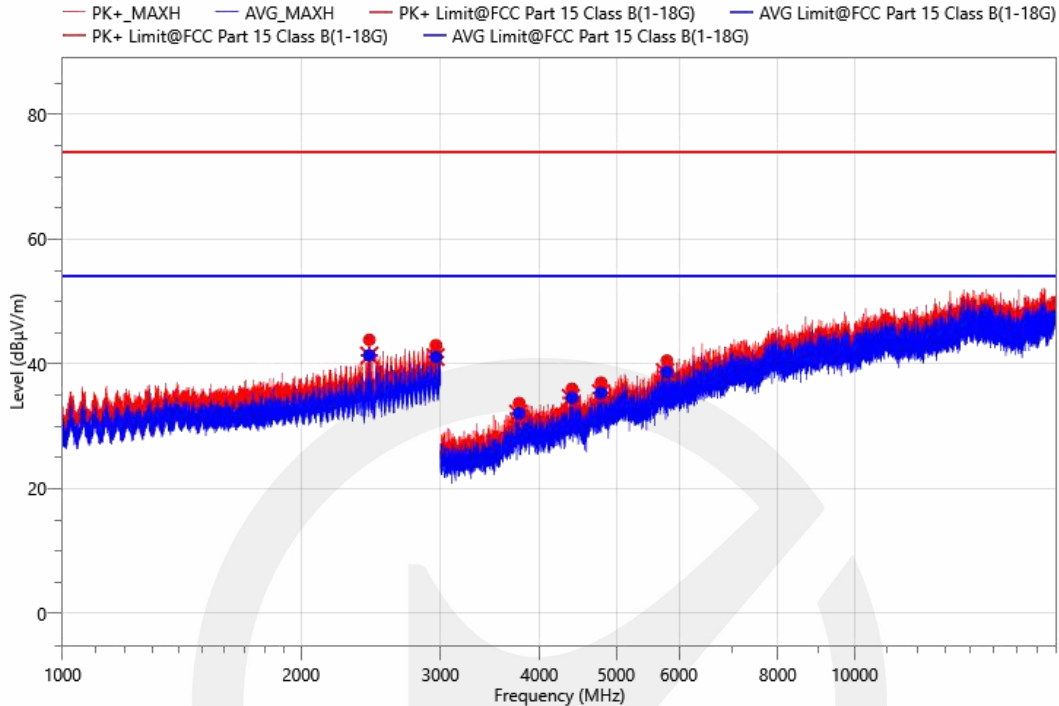

Freq. (MHz)	Reading (dBµV)	Meas. (dBµV/m)	Limit (dBµV/m)	Margin (dBµV/m)	Det.	Height (cm)	Pol.	Azimuth (deg)	Corr. (dB)	Verdict
2439.25	53.37	43.87	74.00	30.13	PK+	100.0	H	120.6	-9.5	Pass
2439.25	50.86	41.36	54.00	12.64	AVG	100.0	H	120.6	-9.5	Pass
2961.06	50.36	43.00	74.00	31	PK+	100.0	H	120.6	-7.36	Pass
2961.06	48.46	41.10	54.00	12.9	AVG	100.0	H	120.6	-7.36	Pass
3771.50	44.41	33.73	74.00	40.27	PK+	100.0	H	120.6	-10.68	Pass
3771.50	42.72	32.04	54.00	21.96	AVG	100.0	H	120.6	-10.68	Pass
4397.00	44.69	36.02	74.00	37.98	PK+	100.0	H	120.6	-8.67	Pass
4397.00	43.23	34.56	54.00	19.44	AVG	100.0	H	120.6	-8.67	Pass
4784.50	44.55	37.00	74.00	37	PK+	100.0	H	120.6	-7.55	Pass
4784.50	42.89	35.34	54.00	18.66	AVG	100.0	H	120.6	-7.55	Pass
5795.00	44.63	40.53	74.00	33.47	PK+	100.0	H	120.6	-4.1	Pass
5795.00	42.80	38.70	54.00	15.3	AVG	100.0	H	120.6	-4.1	Pass

7. PHOTOGRAPHS

7.1. Photo of Conducted Emission Measurement

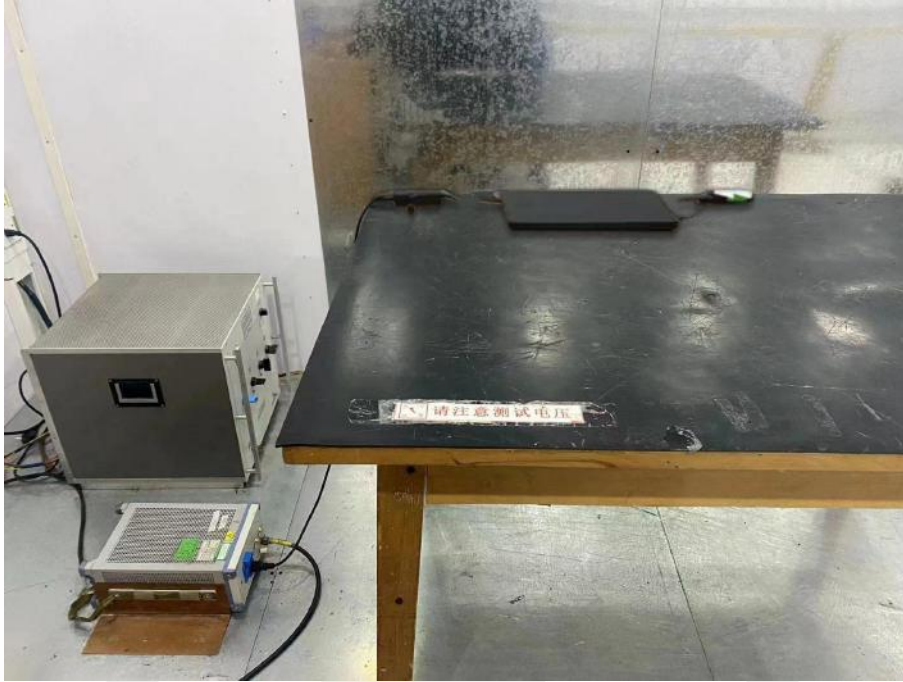

7.2. Photo of Radiation Emission Measurement (Up to 1GHz)



7.3. Photo of Radiation Emission Measurement (Above 1GHz)

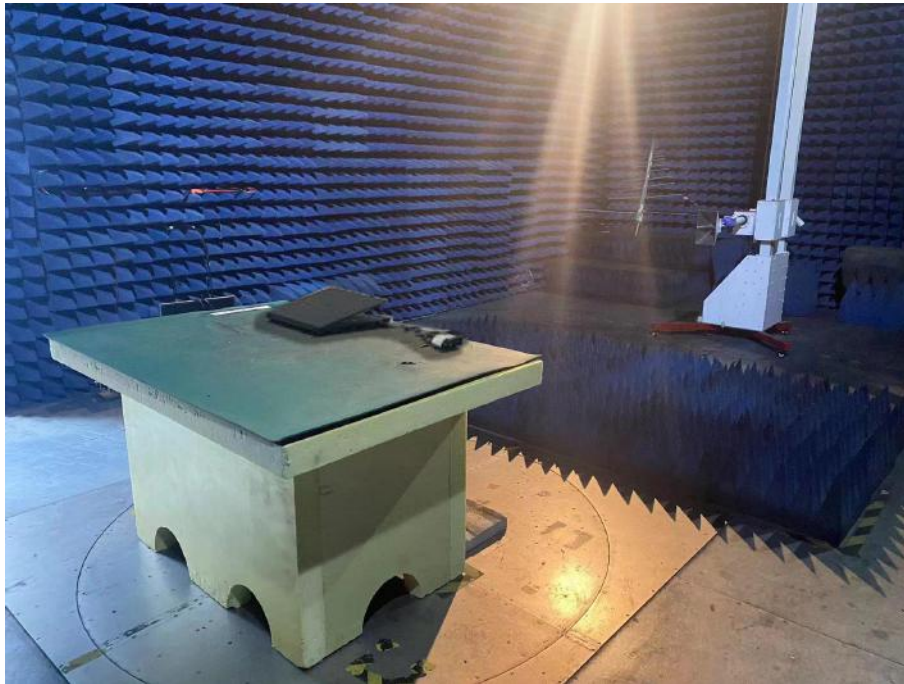

APPENDIX A: Label Requirements

(1) Receivers associated with the operation of a licensed radio service, e.g., FM broadcast under part 73 of this chapter, land mobile operation under part 90 of this chapter, etc., shall bear the following statement in a conspicuous location on the device:

This device complies with part 15 of the FCC Rules. Operation is subject to the condition that this device does not cause harmful interference.

(2) A stand-alone cable input selector switch, shall bear the following statement in a conspicuous location on the device:

This device complies with part 15 of the FCC Rules for use with cable television service.

(3) All other devices shall bear the following statement in a conspicuous location on the device:

This device complies with part 15 of the FCC Rules. Operation is subject to the following two conditions: (1) This device may not cause harmful interference, and (2) this device must accept any interference received, including interference that may cause undesired operation.



APPENDIX B: Warning Statement

(a) For a Class A digital device or peripheral, the instructions furnished the user shall include the following or similar statement, placed in a prominent location in the text of the manual:

NOTE: This equipment has been tested and found to comply with the limits for a Class A digital device, pursuant to part 15 of the FCC Rules. These limits are designed to provide reasonable protection against harmful interference when the equipment is operated in a commercial environment. This equipment generates, uses, and can radiate radio frequency energy and, if not installed and used in accordance with the instruction manual, may cause harmful interference to radio communications. Operation of this equipment in a residential area is likely to cause harmful interference in which case the user will be required to correct the interference at his own expense.

(b) For a Class B digital device or peripheral, the instructions furnished the user shall include the following or similar statement, placed in a prominent location in the text of the manual:

NOTE: This equipment has been tested and found to comply with the limits for a Class B digital device, pursuant to part 15 of the FCC Rules. These limits are designed to provide reasonable protection against harmful interference in a residential installation. This equipment generates, uses and can radiate radio frequency energy and, if not installed and used in accordance with the instructions, may cause harmful interference to radio communications. However, there is no guarantee that interference will not occur in a particular installation. If this equipment does cause harmful interference to radio or television reception, which can be determined by turning the equipment off and on, the user is encouraged to try to correct the interference by one or more of the following measures:

- Reorient or relocate the receiving antenna.
- Increase the separation between the equipment and receiver.
- Connect the equipment into an outlet on a circuit different from that to which the receiver is connected.
- Consult the dealer or an experienced radio/TV technician for help.

Warning: Changes or modifications to this unit not expressly approved by the party responsible for compliance could void the user's authority to operate the equipment.

APPENDIX C: Photos of EUT

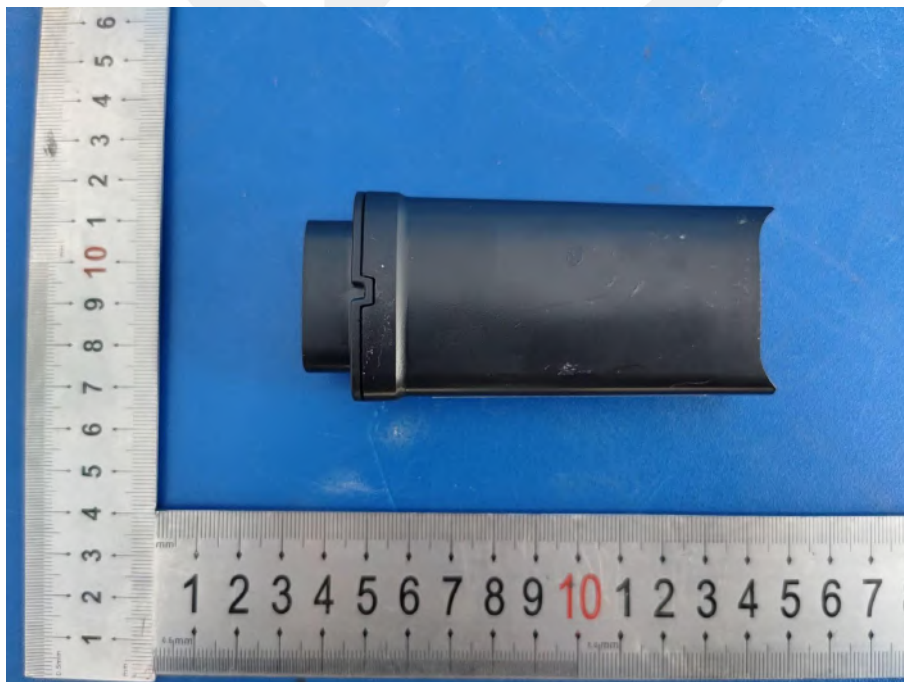



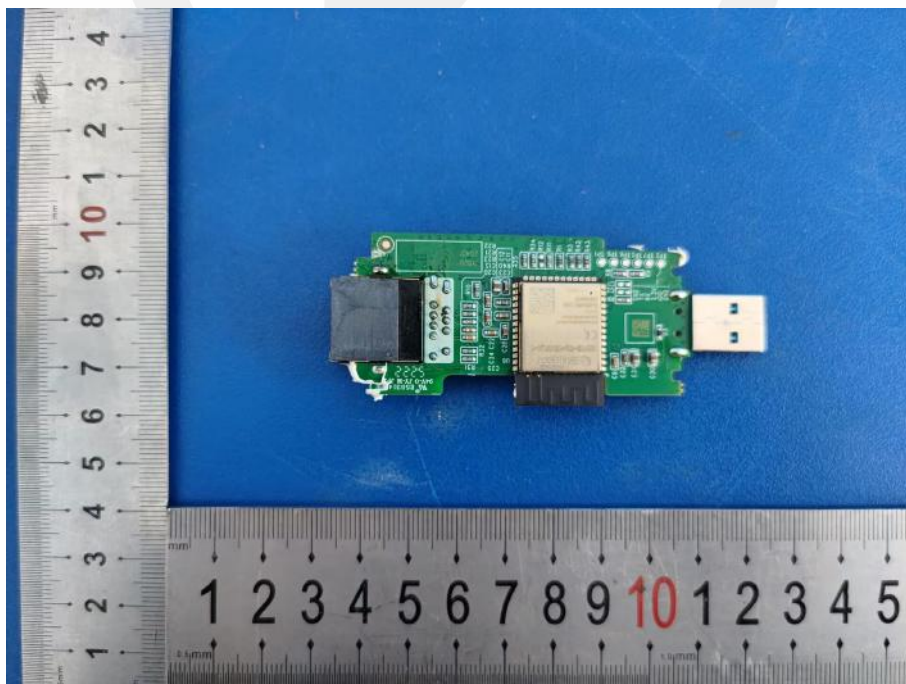

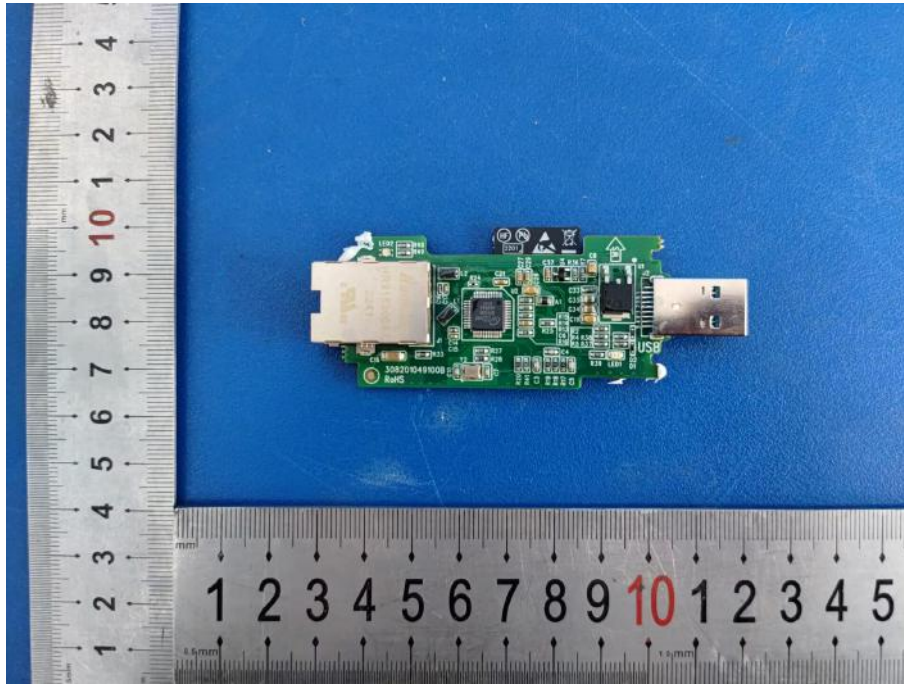

*** End of Report ***

声明

Statement

1. 本报告无授权批准人签字及“检验检测专用章”无效；
This report will be void without authorized signature or special seal for testing report.
2. 未经许可本报告不得部分复制；
This report shall not be copied partly without authorization.
3. 本报告的检测结果仅对送测样品有效，委托方对样品的代表性和资料的真实性负责；
The test results or observations are applicable only to tested sample. Client shall be responsible for representativeness of the sample and authenticity of the material.
4. 本检测报告中检测项目标注有特殊符号则该项目不在资质认定范围内，仅作为客户委托、科研、教学或内部质量控制等目的使用；
The observations or tests with special mark fall outside the scope of accreditation, and are only used for purpose of commission, research, training, internal quality control etc.
5. 本检测报告以实测值进行符合性判定，未考虑不确定度所带来的风险，本实验室不承担相关责任，特别约定、标准或规范中有明确规定的除外；
The test results or observations are provided in accordance with measured value, without taking risks caused by uncertainty into account. Without explicit stipulation in special agreements, standards or regulations, EMTEK shall not assume any responsibility.
6. 对本检测报告若有异议，请于收到报告之日起 20 日内提出；
Objections shall be raised within 20 days from the date receiving the report.